

22" Outdoor PCAP Wall-Mounted Touch Screen Displays



PCAP Touch Screen

State-of-the-art projected capacitive technology provides the most responsive and sensitive touch experience available, as well as offering superior optical quality. Unlike other touch technologies, PCAP is not affected by dust or debris on the surface of the screen.



Weatherproof

Designed to withstand the elements, these displays are protected against all wet weather conditions and airborne dust particles by their robust IP65 rated enclosure. They also feature a waterproof coating on all internal circuit boards and waterproof over-moulded AV connectors.

IP65

- 6** Dust Resistance
Protected against dust that may harm equipment.
- 5** Water Resistance
Protected against water spray from all directions.



Sunlight Readable



Vandal Proof



No Ghost Touch



Advanced Temperature Control System



Ambient Light Sensor



Anti-Reflective Glass



Free Lockable Wall Mount



Protective UV Film



Android Media Player



Customisation Available

Other Features

Vandal Proof

With a mild steel enclosure and thermally-toughened glass front, these IK10 rated displays are designed to withstand any damage that may occur in public spaces. To avoid tampering, controls and inputs are hidden and cannot be accessed by passers-by.

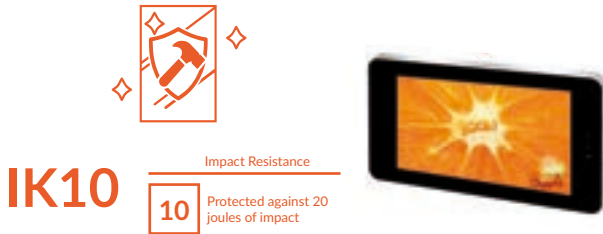

Direct Sunlight Readable

Thanks to their commercial grade ultra-high brightness panels (2,000cd/m²), these displays are up to 10 times brighter than a domestic TV and so are easily readable even in direct sunlight.



No Ghost Touch

The electrodes that control the interactivity are sandwiched between two layers of special protective glass to prevent phantom touches. This ensures ultimate accuracy and a seamless touch experience.



Advanced Temperature Control System

To maximise the lifespan of the display, the internal airflow system keeps the screen running at the optimal temperature regardless of the external conditions. Built-in air conditioning can be tailored to allow the display to work in any climate.

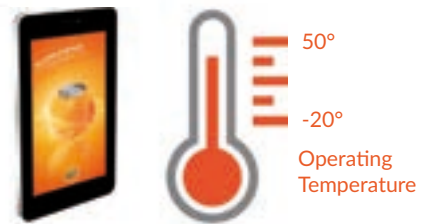

Internal Locker

Should you need run the screen from an external source, there is space to fit a small PC or media player inside the lockable compartment. This can then be connected to the display via the HDMI, VGA or 3.5mm audio inputs.



Anti-Reflective Glass

The front glass face is specially treated to help diffuse direct sunlight, making the display easily readable even in bright weather conditions.



Ultimate UV Protection

The front glass of the display utilises a special UV treatment that reduces the internal heat of the enclosure by up to 71%; reducing the number of cooling fans needed and increasing the life of your display.



Customisation Available

Bespoke displays can be manufactured to order should you require a non-standard solution, to incorporate a camera for example. We can also modify existing models to add a 4G module for mobile connectivity or a vinyl logo/wrap.



Key Features



PCAP TOUCH SCREEN



2,500 CD/M²
SUNLIGHT READABLE



IP65 RATED



VANDAL PROOF HIGH GAIN
WI-FI AERIAL



PROTECTIVE UV FILM



10 TOUCH POINTS



PLUG AND PLAY



LANDSCAPE OR PORTRAIT
ORIENTATION

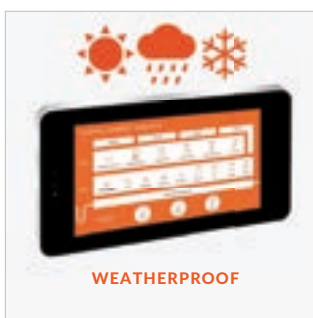

WEATHERPROOF

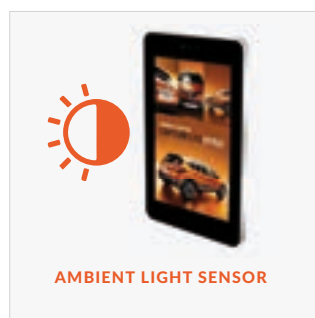

AMBIENT LIGHT SENSOR

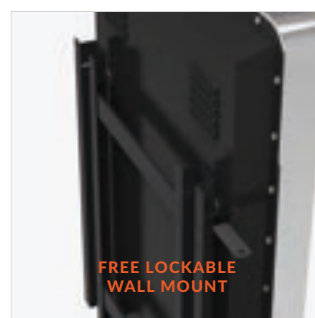

FREE LOCKABLE
WALL MOUNT

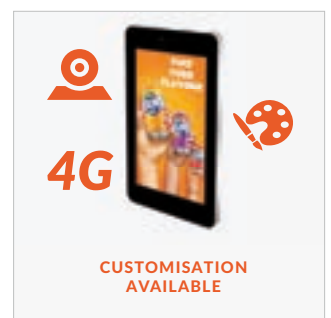

4G

CUSTOMISATION
AVAILABLE

Specification Table

		22 Inch
Panel	Resolution	1920x1080
	Display Area (mm)	477x270
	Aspect Ratio	16:9
	Brightness (cd/m ²)	2,000
	Colour	16.7M
	Viewing Angle	178°
	Contrast Ratio	8000:1
Touch	Touch Technology	Projected Capacitive
	Touch Points	10
	Glass Hardness	4H Minimum
AV Inputs	Video	HDMI, VGA (Internal)
Power	Power Consumption (W)	130
	Input Voltage	AC110~240V (50Hz~60Hz)
Mechanical	Unit Size (WxHxD mm)	737x397x120
	Package Size (WxHxD mm)	860x560x280
	Landscape VESA Holes (mm)	250x250
	Portrait VESA Holes (mm)	
	Net Weight (kg)	22
	Gross Weight (kg)	27
	IK Rating	IK10
Environmental	Operating Temperature:	-20 °C to 50 °C
	Operating Humidity:	10% - 80%
	Storage Temperature:	-30°C - 60°C
	Storage Humidity:	5% - 90%
	Enclosure Protection	IP65
Computer	Media Formats	Video (MPG, AVI, MP4, RM, RMVB, TS), Audio (MP3, WMA), Image (JPG, GIF, BMP, PNG)
	Media Resolution	1920x1080/1080x1920
	Internal Memory	6GB
	CPU	Quad-Core Cortex-A17@1.61GHz
	GPU	Mali-T760 MP4 @600MHz
	RAM	2GB DDR3
	Internal Storage	8GB NAND
	USB	USB2.0 HOST (x2)
	LAN	10/100/1000Mb/s Ethernet
	Wi-Fi	802.11b/g/n/ac
	OS	Android 5.1.1
	Graphic Engine	OpenGL ES 1.1/2.0/3.0/3.1, OpenCL 1.1, Renderscript, Direct3D 11.1
	Accessories	Included
Optional		Network Upgrade, Camera
Warranty	Warranty Period	3 Year Warranty
	Technical Support	Lifetime

Errors and omissions excepted



Bracket

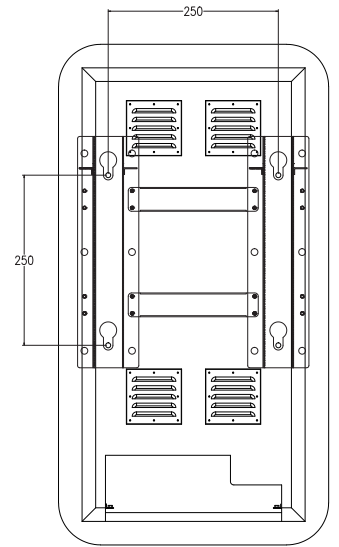
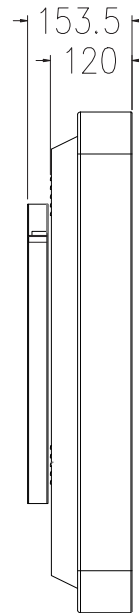
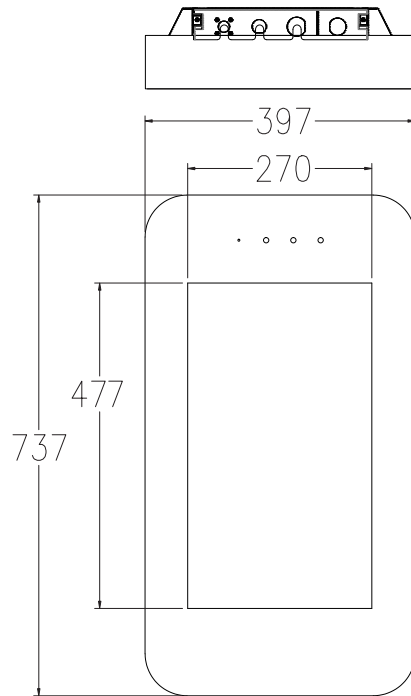
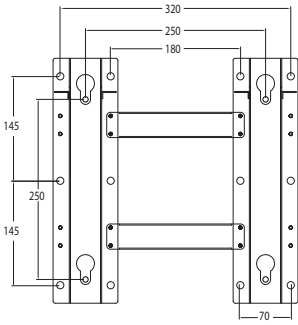

Why Choose Our Commercial Display Solutions?



Lifetime Technical Support

From the moment you receive your product, throughout the duration of your warranty and even after your warranty has expired we are here to support you. If you require any assistance setting up or using your product, or have any problems at all, we can provide free technical support via telephone and email.

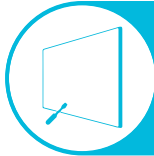

On-site Support and Maintenance*

If needed, we can provide an installation service for any of our products. We can also set up service-level agreements for larger projects that require maintenance contracts.



Extended Warranty*

All of our commercial display products come with a 3 year commercial warranty as standard but if you want to extend this you can upgrade this to cover a 5 year period at point of purchase.



Training

As well as providing free remote CMS training sessions and webinars we can also visit you to deliver bespoke training for our software and hardware*.



Advanced Replacements†

Should your display suffer from any kind of hardware failure during the warranty period we will send you an advanced replacement and arrange for your old display to be collected, free of charge. This ensures no downtime where you are without a screen.



Custom Product Testing & Configuration

If you need us to test third party software or a website, or configure your screen in a particular way before it is dispatched (e.g. in a particular orientation or network mode), we can do so to make your life easier.



3D Rendering

Want to know how a particular screen will look once installed? Send us a photo of the location and we will create a 3D rendering of any screen in situ to help you to visualise how amazing it will look.



Logistics Support

We hold more stock in our UK warehouse than any other manufacturer so we can help you meet tight deadlines. For last minute orders we can also offer special express or morning delivery options*. We also carry out UK based quality control checks on every display before it leaves our warehouse.



Project Support

If you need to loan a sample unit to test we'd be more than happy to arrange this. We can also provide a rental service for temporary projects*.



Customisation*

Your display can be customised to suit your requirements by adding your logo or printed graphics or even tailoring the colour of a display. We can also carry out hardware modifications to existing products or manufacture bespoke solutions for special projects.



Extras*

As well as being able to provide accessories and add-ons, such as extra remote controls, NUC PCs and video wall controllers, we can also supply custom made flight cases which are great if a display needs to be moved safely from place to place.

†UK mainland only

*These particular services may incur additional charges